

Automatic monitoring and control of museums' environment based on Wireless Sensor Networks

L.M. Rodríguez Peralta, L.M.P.L. Brito, B.A.T. Gouveia, D.J.G. Sousa, & C.S. Alves

Exact Sciences and Engineering Centre, University of Madeira (UMa)

Campus da Penteada

9000-390 Funchal, Madeira, Portugal.

{lmrodrig; lina}@uma.pt; {brunogouveia10; daliajs}@hotmail.com; alves.cs@gmail.com

Abstract – In museums, it is critical to properly conserve the existing artwork. For this purpose, it is fundamental to continuously monitor its environment, either in storage or exhibition rooms. Contrarily to traditional measuring equipments and procedures used in museums, the deployment of a Wireless Sensor Network (WSN) can help to implement these measurements continuously, in a real-time basis, and in a much easier and cheaper way. This is the main objective of the WISE-MUSE project, which proposes the use of WSNs for museums' environmental and structural monitoring, and automatic environmental control. In this paper, the implementation and the main results of the WISE-MUSE project, which was carried out in a contemporary art museum, are described. Among other important contributions that will also be described in this paper, the development of a new wireless sensor node and a Web-based visualization tool, which bring some considerable advantages when compared with other commercially available solutions, are emphasized.

1. INTRODUCTION

The degradation of artwork in museums is a result of them being exposed to human intervention but, above all, to environmental variations. Therefore, monitoring the museum's environment is one of the most important tasks and concerns of all museums' managers. As a result, it is critical to continuously measure and control some parameters, such as temperature, relative humidity, light, and, also, pollutants (in the context of a museum, pollutants can be: carbon dioxide, several types of acids, dust particulates, etc.), either in exhibition or in archival collections.

The required values for environmental parameters depend on the type of material or on the group of materials (typical in contemporary art) that constitute the artwork. So, depending on the type of works that are in exhibition or in storage rooms, different rooms may have different requirements

regarding environmental conditions. Basically, the main goal of preventive artwork conservation is to maintain the artefacts under nearly constant levels of, above all, humidity and temperature. However, in the case of rare objects and artefacts, the temperature and humidity levels must be very precisely controlled.

Those managers in charge of historic buildings have the added complexity of preserving not only the existing artwork but also the building's historic structure. On the other hand, it is very important to minimize the visual impact caused by monitoring systems in this type of environments for esthetical reasons. So, both kinds of protection must be accomplished with minimal intrusion from the monitoring system being installed and under increasing economic limitations.

A Wireless Sensor Network (WSN) typically consists of a large number of tiny wireless sensor nodes (often simply referred to as nodes or motes)

that are densely deployed (Akyildiz et al., 2002). Nodes measure some ambient conditions in the environment surrounding them. These measurements are, then, routed to special nodes, called sink nodes (or Base Station), typically in a multi-hop basis. Then, the sink node sends data to the user.

A sensor node typically consists in five components: sensing, memory, processor, transceiver (transmitter and receiver) and battery. Nowadays, nodes are intended to be small and cheap. Consequently, there are equipped with limited resources (typically, limited battery, and reduced memory and processing capabilities). Due to short transmission range (caused by restrained transmission power), nodes can only communicate locally, with a certain number of local neighbours (Akyildiz et al., 2002). Nevertheless, taking advantage of its hardware resources and, especially, of its wireless communications capability, WSNs allow for a wide range of applications: environmental monitoring, catastrophe monitoring, health, surveillance, traffic monitoring, structural monitoring, security, military, industry, agriculture, home, etc.

The deployment of a WSN in a museum can help implementing the environmental monitoring continuously, and in a much easier and cheaper way. Apart from cost and flexibility, the use of WSNs can bring several advantages: 1) it causes almost no visual impact in visitors due to the small size of sensor nodes and to the absence of cables, what is extremely important in a museum; 2) it eliminates the problems inherent to traditional measuring equipments, such as mechanical hygrothermographs, psychometers and hygrometers; there are no moving parts to break and calibration does not change; 3) finally, there is no need for specialized employees to implement these measurements, as occurs when traditional equipments are used.

In this paper, the WISE-MUSE project is presented, which aims at monitoring the environment of a contemporary art museum called Fortaleza São Tiago, located in Madeira Island, Portugal, both for artwork and building conservation purposes. Regarding this project, its objectives, its architecture, and its implementation are described. One of the main contributions of WISE-MUSE project is also presented, which is a new wireless sensor node that was developed specifically to environmental monitoring applications, but considering the specific requirements of the

museum, namely reduced size and cost. Moreover, the problems identified at this implementation phase are highlighted, which will influence the final deployment of the complete WSN. Furthermore, in order to improve the user awareness concerning the deployed WSN, this network is modelled and represented using the CWSN (Collaborative Wireless Sensor Networks) model, a graph-based formal model specifically created for WSNs.

This paper is organized as follows. Section 2 describes the related work in the area of WSNs applied to the monitoring of museums or historical buildings. Section 3 presents the need for environmental monitoring of museums and proposes the use of WSNs as a cheap and suitable solution. Still in this section, the objectives of the WISE-MUSE project are outlined, and a practical WSN deployed in the museum is described as well as the respective network topology. Then, a new sensor node prototype is presented, and a humidity control device is described. Besides, some experimental results are described, and the problems identified during these experiments are outlined. Section 4 describes a monitoring system that is being developed specifically for WSNs, whereas Section 5 and 6 respectively provide some conclusions and perspectives of future work.

2. RELATED WORK

Nowadays, there are some works related to the deployment of WSNs in museums; nevertheless, the most common applications are, usually: to use WSNs for security reasons (Onel et al., 2006; Wang et al., 2007); or to monitor the number and distribution of visitors in the museum (Pai et al., 2007); or for the creation of interactive museums (Pai et al., 2007; Heidemman & Bulusu, 2001; Oldewurtel and Mähönen, 2006).

There are some wireless equipments commercially available that measure humidity and temperature (Omega, 2009; 2DI, 2009); however, they are bigger and more expensive than most wireless sensor nodes.

Spinwave Systems offer a solution for preserving a building's architecture using WSNs (Spinwave, 2009). Spinwave claim to provide precise control and monitoring of environmental variables, such as temperature and humidity, in buildings where wired sensors are not feasible or are prohibitively

expensive. However, they do not monitor light or pollutants. Besides, their nodes are expensive. They also claim to ensure minimal disruption to building occupants and improved indoor climate; but, nodes are quite big for being applied in an environment where visual impact is of extreme importance.

Lee et al. (2008) present a scenario of applying WSNs to monitor the environment of art galleries, but focusing in measuring only humidity and temperature. However, the paper focus on a different problem, i.e., on evaluating the efficiency of the ALOHA protocol without retransmission, when transmitting from sensor nodes to a base station. Del Curto & Raimondi (2006) present a work where WSNs have been used for preserving historic buildings. Crossbow manufacturers (Crossbow, 2009) present two systems to be applied in museums and archives: a system that monitors humidity and temperature, the CLIMUS, and a system that controls the air conditioning unit, the REAQUIS. However, they do not use WSNs; sensors used are wired are much bigger than wireless sensor nodes commercially available.

Our main goal is to create a WSN for monitoring and automatically control of the most critical environmental parameters, which are the humidity, temperature, and light, in museums (exposition rooms and storage rooms). The sensor nodes used in the WISE-MUSE project are smaller and cheaper than the ones used by Spinwave (2009). These factors are the basis for making our solution more suitable to the environmental monitoring of museums or historical buildings. Pollutants are also of major concern for museum managers; thus, our project aims at monitoring pollutants, but in a subsequent phase of the WISE-MUSE project.

3. APPLYING WSNS TO MUSEUMS' ENVIRONMENTAL MONITORING

Today's museum managers are faced with the constant demand of gaining greater control of the indoor environment for preventive conservation of art purposes, under increasing budgetary constraints. In the particular case of Fortaleza São Tiago, in Madeira Island, Portugal, environmental measurements are performed in a very rudimentary way, using traditional and very expensive measuring equipments, such as mechanical hygrothermographs, psychometers and hygrometers. These

measurements take too long to be performed in the whole museum and require a specialized person for this purpose. Besides, these equipments require calibration and cause visual impact on visitors and on exhibition rooms. For all these reasons, these measurements have not been performed as often as they should, which means several times a day. In contrast, measurements are usually carried out once a day. Furthermore, the administration choice regarding a more flexible and practical solution is limited by severe budgetary constraints.

The deployment of a WSN in a museum can help to implement these critical measurements automatically, continuously, and in a much easier and cheaper way. It causes almost no visual impact due to the small size of sensor nodes and to the absence of cables, what is extremely important in a museum. Also, it eliminates the problems inherent to traditional measuring equipments; there are no moving parts to break and it stays in calibration.

The WSN deployment carried out at the Fortaleza São Tiago museum, in the context of the WISE-MUSE project, consists of a small group of wireless nodes capturing environmental data continuously. Data collected by sensor nodes is sent wirelessly to a database, through the sink node that is connected to a PC. Data can be visualized, in real time, through a web-based platform, in different ways: tables, graphs, colour gradients, data reports, etc.

Some of our preliminary work has been already published (Brito et al., 2008), but it refers to tests that were conducted using a commercial sensor. Another published paper (Rodríguez et al., 2009) covers the first results of the WISE-MUSE project. On the opposite, the current paper presents some final results of this project, and all the presented results refer to experiments performed with a new wireless sensor node prototype that was developed by us.

3.1 The WISE-MUSE Project

As main goals, the WISE-MUSE project comprises:

1. To create a WSN for monitoring the most critical environmental parameters in museums (both in exposition and storage rooms).
2. To monitor pollutants as they are also a major concern for museum managers.
3. To give users and museum' managers the possibility of consulting the collected data in real time, via different data formats (e.g., graphs,

tables, colour gradients, etc.), and consulting the data historic whenever needed.

4. To analyse data in order to verify its compliance with the art conservation rules. If a significant variation (below or above the required levels) on at least one of the measured parameters occurs, an alert has to be automatically sent to the user through a mobile phone (text message) or e-mail, in order to increase the efficiency of this environmental monitoring system.
5. To control the environmental conditions through the automatic control of the air conditioning and dehumidifying systems of the museum.
6. To visualize data integrated in a 3D representation of the building.
7. To install a system based in wireless video cameras that improves security by sending alerts in case of intrusion or robbery.

The architecture of the WISE-MUSE project, which is represented in Figure 1, is composed by several modules. As this is still an ongoing project, the implementation of some of the modules, like the notification system, the sessions' management tool, is in its final stage, but some particular aspects remain to conclude their implementation; therefore, these modules will not be covered in this paper. Then, in this paper, the main modules that were implemented will be described, namely the automatic control of air conditioning and dehumidifying systems, and the monitoring system that consists of a 3D awareness tool and a web visualization tool that were developed specifically for WSNs.

The data analyser is the first main module of this architecture and it transforms the raw data collected by wireless sensor nodes into international system (IS) measuring units; this module sends the RSSI (Received Signal Strength Indicator) parameter to the module that is responsible for implementing a localization algorithm, which will compute the positions of sensor nodes*, and sends environmental data to the module that is responsible for the automatic control of air conditioning and dehumidifying devices.

The data output from the data analyser is saved into a database and, then, exported to an XML file. The XML files are used not only as an input for the

awareness tool but, also, for the web-based visualization tool. The collection of XML files saved in the database compose the data historic, which can be consulted whenever the user need

3.2 WSN Deployment Scenario

An experimental testbed was implemented with the aim of essentially testing the behaviour of the new wireless sensor nodes and the visualization tool, and at identifying possible problems regarding both the nodes and the application scenario.

These experiments were conducted inside two storage rooms located in the first floor of the museum of contemporary art, named Fortaleza São Tiago, which is illustrated in Figure 2. These storage rooms are the compartments most affected by humidity and, consequently, where the environmental monitoring and control is more urgent.

This experimental testbed was carried out with sensor nodes that communicate using the ZigBee protocol, given that sensor nodes are equipped with XBee radios (Digi, 2009), as will be described in section 3.5. It is important to point out that the ZigBee protocol defines three types of devices: end devices, routers and coordinators (ZigBee Alliance, 2004). End devices correspond to sensor nodes with sensing capabilities; routers are sensor nodes that can also sense data, but they are essentially responsible for routing data collected by the end devices located in their WPAN (Wireless Personal Area Network) to the coordinator; and, finally, the coordinator corresponds to the sink node.

3.3 WSN Deployment

Before actually deploying the WSN, it was necessary to study and determine the best location of nodes and the amount of nodes needed to cover both storage rooms, located in the first floor, and to ensure that these nodes are able to communicate with the coordinator that has to be located in the office, in the second floor, as required by museum' managers. Both storage rooms and the office are separated by an outdoor space.

Therefore, this study involved characterizing the indoor and outdoor signal propagation, the obstacles and other factors that may restrict signal propagation, and to evaluate the real transmission range of sensor nodes.

To evaluate the indoor and outdoor signal propagation, extensive signal measurements were

* The reasons for choosing a RSSI-based localization algorithm are outside the scope of this paper.

performed (using the RSSI parameter) inside the two storage rooms located in the first floor, inside the office located on the second floor where the Museum’s staff works, and on the outdoor space which is located among these three places. The material used for studying the signal propagation was:

- *Coordinator*: a Maxstream USB board, an XBee series 2 module from Digi manufacturer, an USB cable, and a laptop computer.

- *Router*: a Maxstream Serie board, an XBee series 2 PRO module, and a Loopback Test.
- *End Device*: a Maxstream USB board, an XBee series 2 module, an USB cable, and a laptop computer.

The software used to obtain the RSSI values was implemented in Java.

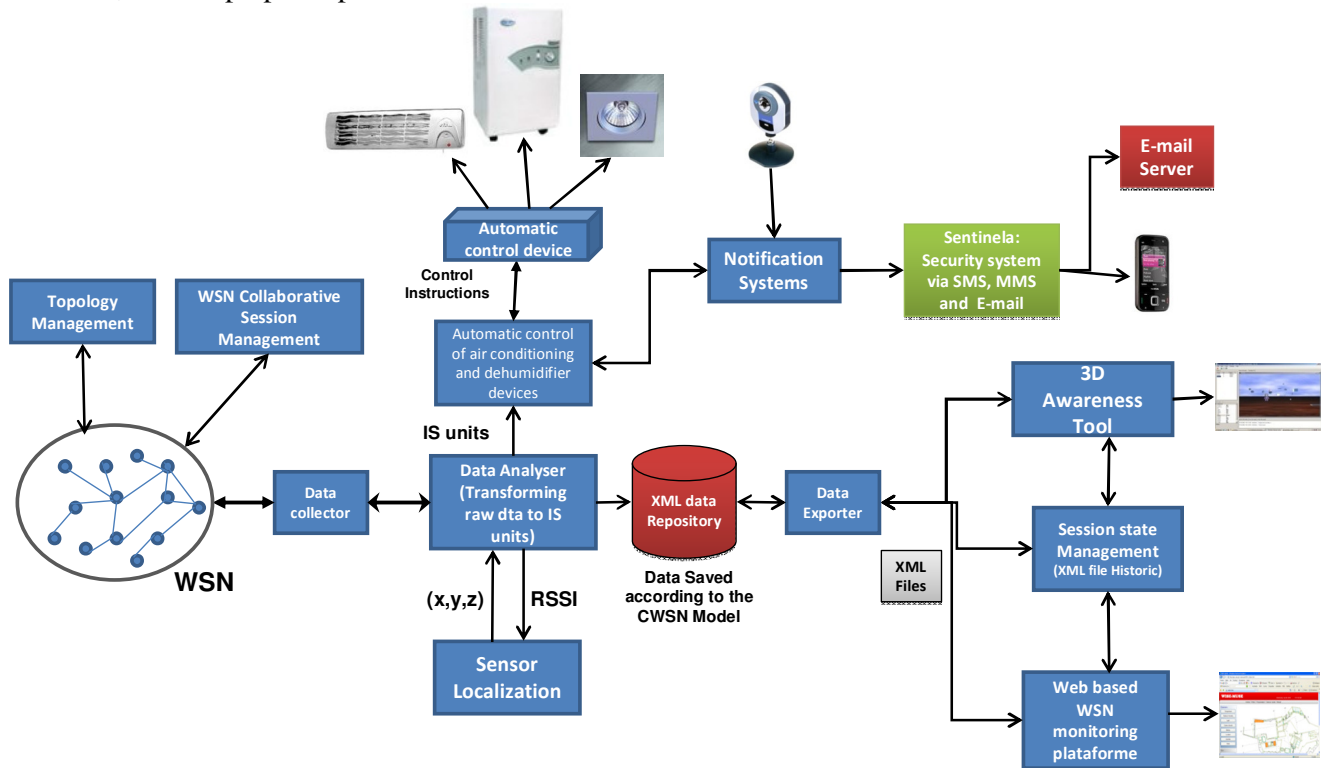

Figure 1. Basic architecture of the monitoring system for WSNs developed in the context of the WISE-MUSE project.



Figure 2. Museum Fortaleza São Tiago and correspondent floor plants.

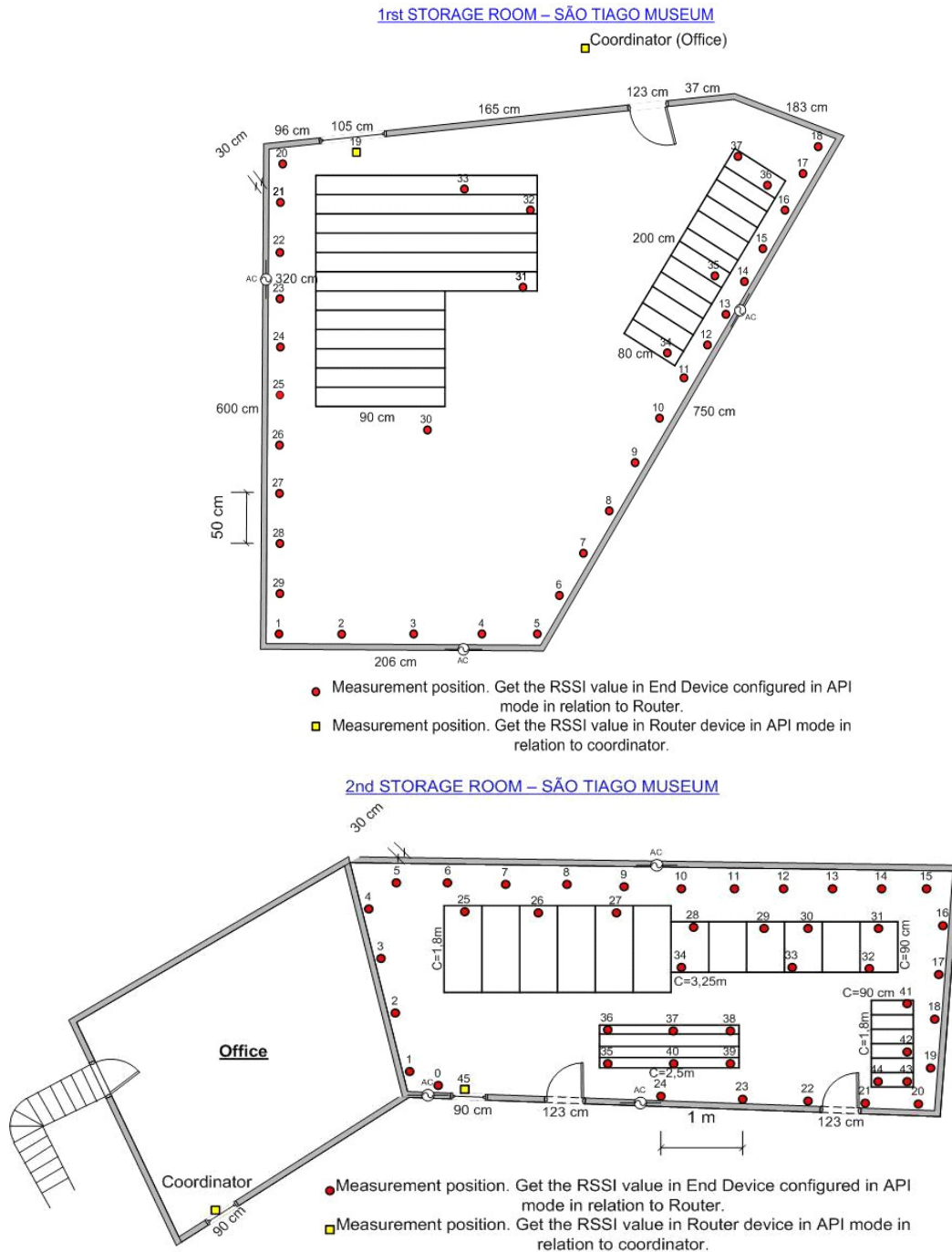

Figure 3. Museum’s storage rooms, where the experimental study of the wireless signal propagation was carried out.

Figure 3 shows the location of the coordinator (office), the router (window of the storage room), and the various locations given to the end device to perform the RSSI measurements. In Table 1 some results from the signal propagation study performed between the router and the coordinator are shown. Note that the transmitting RF power of the XBee radio series 2 module employed in these

measurements is 0dBm (1mW) and its receive sensitivity is - 92dBm, that is, bellow this receive sensitivity value the connection will not be established. For the XBee series 2 PRO, the transmitting RF power is 60 mW (18dBm) and the receive sensitivity is -100dBm.

Thus, the best RSSI value obtained inside the first storage room was in the position number 19 (shaded

in grey), using XBee series 2 and XBee series 2 PRO radios. However, it is important to place the sensor nodes close to the artwork to get a better monitoring. Therefore, the best positions were 13 and 23 (shaded in black), where a good RSSI value was obtained, considering the distance from the nodes to the artwork pieces.

Taking into account the RSSI values obtained in this study, the topologies allowed by ZigBee, and the museum requirement regarding the need for monitoring in the proximity of the artwork pieces, the topology indicated in Figure 4 was defined as the best topology for the storage rooms.

With this study, the transmission range of the nodes was also evaluated. Thus, besides illustrating the localization of nodes, Figure 4 also shows the coverage map. This coverage map is important since it indicates the areas that are more prone to connectivity failures (red areas) and the areas where a good coverage is achieved (green areas). Note that this may suffer some variations given that indoor signal propagation may be affected by possible signal reflections that are not easy to predict.

These signal propagation and coverage studies were fundamental in supporting us to decide not only where to locate the end devices (sensor nodes), but also to decide what was the amount of nodes needed and, consequently, the density of nodes. It was concluded that it was necessary to deploy a total of four end devices, two routers and one coordinator, as Figures 5 and 6 illustrate: two end devices in storage room 1, two end devices in storage room 2 (even though this is a bigger room), one router in each storage room, and one coordinator located at the museum's office.

For being equipped with XBee radios, the deployed nodes automatically form a cluster-tree topology, one of the three types of topologies that ZigBee supports, besides star topology and peer-to-peer (or mesh) topology. For this reason, even though this is a small WSN, two clusters are automatically created.

Currently, this WSN measures the most important parameters, which are the temperature, humidity and light; however, internal voltage is also monitored so that the user is aware of the state of the nodes' batteries. The sensor nodes are programmed to measure and send data to the coordinator each 10 minutes.

3.4 Network Topology

The network topology of the experimental WSN created is illustrated in Figure 7. Its representation is based in the CWSN (Collaborative Wireless Sensor Networks) model. Further information on the CWSN model may be found in (Brito & Rodríguez, 2008).

CWSN is a graph-based formal model of collaborative work specifically designed to WSNs. However, CWSN allows not only the modelling of collaborative work, but also the modelling and visual representation of all the entities that can constitute a WSN, as well as its properties, which is fundamental to completely represent a WSN. The network hierarchy (from the collected data to the user) can be visualized, as well. Moreover, it is a generic model because it can be applied to heterogeneous networks (any type of nodes, any size, any hardware characteristics, any types of signals, etc.), and because it can be applied to describe any network scenario, despite the WSN specific application.

According to the CWSN model definitions, the visual representation of a WSN is carried out using the symbols presented in Table 2. Thus, the specific case of the WSN deployed in the museum can be represented as depicted in Figure 7. From this figure it is possible to conclude that:

- There are two sets of nodes that form two clusters (represented by the hexagons) or two PAN networks, using the ZigBee terminology: one cluster in storage room 1 and the other in storage room 2.
- Nodes N_1 and N_2 are the sensor nodes (end devices), which collect data from the environment of storage room 1, whereas the three nodes N_3 , N_4 and N_5 , are the end devices that collect data from the environment of storage room 2. Storage room 2 is bigger than the other; therefore, it needs more end devices to guarantee that the whole storage area is covered. The end devices are fed by batteries.
- The green colour of nodes N_1 , N_2 , N_3 , N_4 and N_5 indicates that they are in the active state. Nevertheless, these nodes are programmed to go into sleep state (represented by nodes in a light grey colour) to save energy when they are not collecting or transmitting data, or they can go to inactive state (represented by nodes in black colour) if they run out of battery.
- The cluster heads (CH), or routers, can act both as end devices, collecting environmental data, and as routers, being responsible for sending

data of all the nodes that belong to the cluster to the sink node. Each CH is located in a different storage room. Both CHs are directly fed by an electricity socket since they cannot stop

operating; otherwise, the whole WSN operation may be compromised.

- There is one sink node located at the museum's office, which corresponds to the coordinator.

Table 1 – Measurements made in the first storage room in Fortaleza São Tiago museum.

Node Position	API Operation Mode (dBm)*	Standard Height (m)**	Distance between measures (m)	XBee Configuration	Equipment
1	-66	0.5	0.5	End Device	XBee series 2
2	-64	0.5	0.5	End Device	XBee series 2
...					
11	-59	0.5	0.5	End Device	XBee series 2
13	-54	0.5	0.5	End Device	XBee series 2
14	-64	0.5	0.5	End Device	XBee series 2
15	-59	0.5	0.5	End Device	XBee series 2
16	-60	0.5	0.5	End Device	XBee series 2
17	-62	0.5	0.5	End Device	XBee series 2
18	-61	0.5	0.5	End Device	XBee series 2
19	-80/-70	1.10	20	Router	XBee series 2 / XBee series 2 PRO
20	-53	0.5	0.5	End Device	XBee series 2
21	-68	0.5	0.5	End Device	XBee series 2
22	-54	0.5	0.5	End Device	XBee series 2
23	-53	0.5	0.5	End Device	XBee series 2
24	-58	0.5	0.5	End Device	XBee series 2
25	-73	0.5	0.5	End Device	XBee series 2
...					
32	-48	1.10	0.5	End Device	XBee series 2
33	-42	1.10	0.5	End Device	XBee series 2
34	-65	1.10	0.5	End Device	XBee series 2
35	-62	1.10	0.5	End Device	XBee series 2
36	-65	1.10	0.5	End Device	XBee series 2
37	-64	1.10	0.5	End Device	XBee series 2

* Measures made between the Router (fixed position) and the End Device (variable position).

** Height of equipments considered according to the height of artworks and energy localization. The router height is greater due to the high attenuation caused by wall. This way, the router was placed on the window sill to be guaranteed communication with coordinator (office place).



Figure 4. – Final topology and coverage map for the storage rooms of the museum Fortaleza São Tiago.

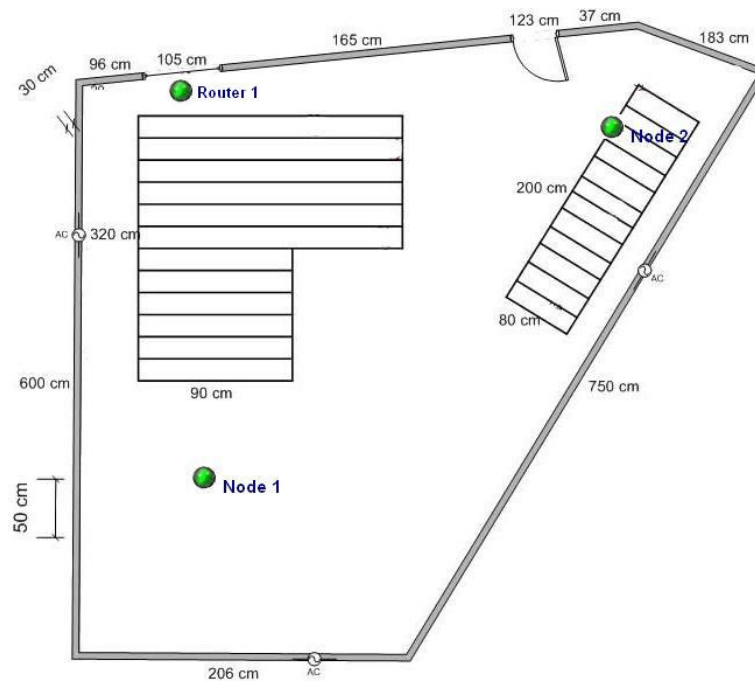

Figure 5. Experimental WSN deployment in Museum Fortaleza São Tiago at storage room 1.

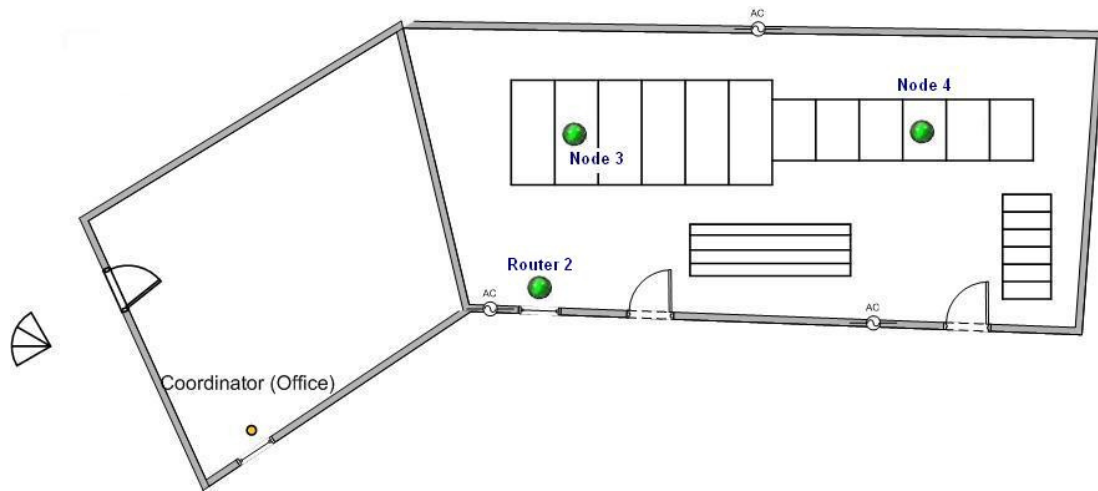

Figure 6. Experimental WSN deployment in Museum Fortaleza São Tiago, at storage room 2 and the manager's office.

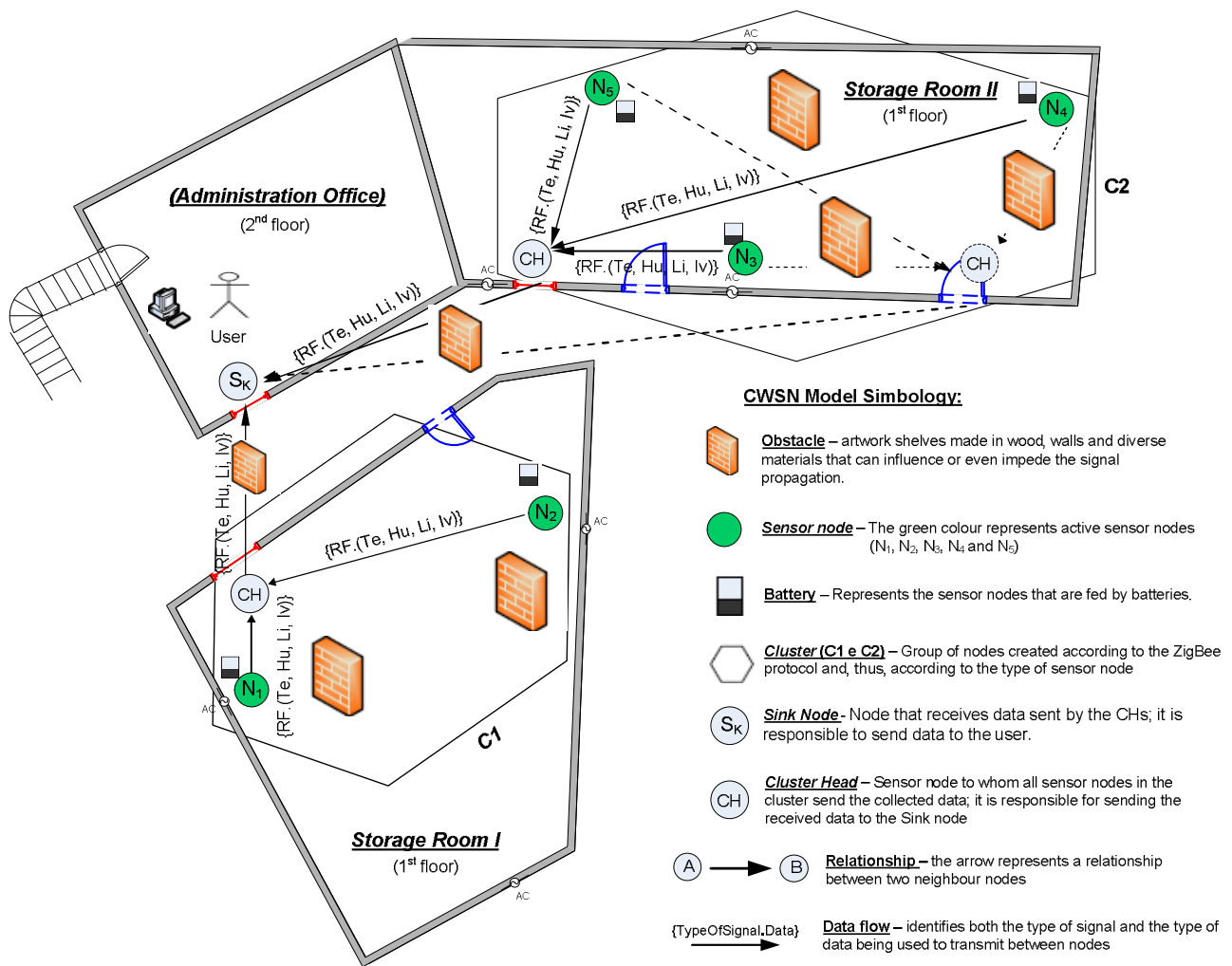

Figure 7. Representation of the WSN created in Fortaleza São Tiago, using the entities and notations defined in the CWSN Model (Brito & Rodríguez, 2008).



Figure 8. Shelves that are used to store artworks in storage rooms, and that impose some restrictions to signal propagation between nodes N_3 and N_4 , and between nodes N_5 , N_6 and N_7 .

- Nodes form a cluster-tree topology: a cluster between end devices and routers, and a tree of clusters considering the communication with the coordinator (the coordinator forms the root of the tree). So, using the CWSN model symbology and notation it is possible to identify the network topology.
- There are relationships between nodes that belong to a cluster and the corresponding CH, and between the CH and the sink node. Communication occurs on a one-hop basis, since the XBee modules do not allow for multi-hop communication.
- All nodes are using radio frequency (RF) to transmit collected data, which encompasses temperature (T_e), humidity (H_u), light (L_i) and internal voltage (I_v).
- There are several obstacles in each storage room, but the most problematic ones correspond to the walls that exist between each CH and the sink node, since they do not obstruct completely the transmission between these nodes but quite difficult it. The remaining obstacles correspond to artworks shelves; a picture of this type of obstacles is shown in Figure 8.

Note that the relationships and the CH represented by a dashed line in storage room 2, correspond to another possibility of locating the CH; however, this possibility conducted to a lower quality WSN.

Therefore, the modelling and representation of the deployed WSN using the CWSN model can bring several advantages from the user and network manager's points of view. The main contribution of the CWSN model is to standardize ways to model a WSN and provide a unified view of such a network regardless of what aspects are considered. Moreover, it allows the user and the network manager to become more aware of the composition and state of the whole network. That is, the CWSN model allows for visually representing several details about the

WSN that has been deployed, what provides them with a more intuitive and prompt understanding of the WSN.

The CWSN model also defines that the evolution of the network can be represented through a succession of graphs, even though this aspect is not exemplified in this paper. Finally, it is important to emphasize that the CWSN model is being used for the development of a 3D awareness tool that will be described in section 4 of this paper.

3.5 Development of a New Wireless Sensor Node

The new wireless sensor node developed by us is shown in Figure 9. It is designed specifically for environmental monitoring applications, but also considering the specific requirements of the museum, for example, reduced size and cost. This device emerges as the element that collects the environmental parameters, such as temperature, humidity and light. In addition to these three parameters, it is possible to send the battery status (internal voltage) and the RSSI signal. The sensor node transmits the captured data to the base station, via RF.

The radio module used is the XBee or the XBee PRO, from the Digi manufacturer (Digi, 2009), which operates according to the ZigBee protocol, i.e., it is designed according to the IEEE 802.15.4 standard and to support the specific requirements of WSNs.

As explained before, to meet the requirements of the museum in terms of the physical location of the rooms that needed to be covered by the WSN and, consequently, in terms of transmission range (please consult section 3.3) it was necessary to employ a cluster-tree topology. As a result, the type of nodes that had to be deployed were some end devices, some routers and one coordinator. The end devices and the routers were developed by us, whereas the coordinator was acquired to DIGI manufacturer. Nevertheless, the router created can also act as an end device whenever needed; in our experiments, it was used as both a router and as end device.

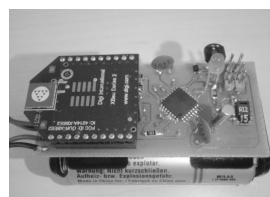





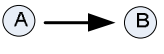
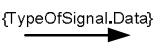







Figure 9. New WISE-MUSE sensor node.

Table 2 – Brief description of the *entities* defined by the CWSN Model (Brito & Rodríguez, 2008), and their symbology.

Symbol	Concept	Description
	Sensor node	Wireless sensor nodes are typically equipped with limited resources, but with multiple sensors. Sensor nodes can be either stationary or mobile. Also, they can be in one of three possible states: active, sleep mode (in order to save energy), or inactive.
	Sink node or Base Station	Node to which data collected by ordinary wireless sensor nodes is sent, being responsible to send data to the gateway. If there is only one sink node, all data collected by sensor nodes has to be sent to it. Otherwise, data may be sent to any sink node and, in this case, usually sink nodes must be able to communicate to each other
	Anchor node	Node with known localization, which support the other sensor nodes in the localization process.
	Cluster	Group of nodes, created according to: geographical area, type of sensor, type of phenomenon, task, etc.
	Cluster Head	Sensor node to whom all nodes in the cluster send the collected data; the cluster head is responsible for sending the received data to the sink node.
	Relationship	The arrow represents a relationship between nodes A and B. It also represents an adjacency relationship between nodes A and B; nodes A and B are direct neighbours. A relationship can be established based on: localization, phenomenon, type of sensor node, etc.
	Data flow	This label identifies both the type of signal being used (radio frequency, ultrasound, acoustical, light or hybrid) and the type of data being transmitted between nodes (temperature, humidity, light, sound, video, internal voltage, etc.).
	Gateway	Device responsible to send the data to the user, through the Internet or satellite. Thus, it is used in the case of remote monitoring.
	Obstacle	An object (building, tree, rock, etc.) which may obstruct the line-of-sight between two or more nodes; depending on the type of antenna and on the type of signal that is being used by nodes (radio frequency, optical, acoustical, etc.), the obstacles may not even allow for communication between nodes.
	Session	In a certain moment, there may be several collaborative sessions in a WSN. A session can be established based on the objective (type of phenomenon to monitor, geographical area to monitor, etc.) of the WSN.
	Battery	It represents the percentage of the node's remaining battery.
	User	Person that interacts with the WSN, querying the network, visualizing data, etc. The user customizes the work of the sensor nodes; the data collected by sensor nodes is used by the users' application.

The differences between the end devices and the routers, at the hardware level, reside in the power supply module since the router has to be connected to an electricity socket; it can never be turned off or be in sleep mode. At the software level, there are also some differences since it has to be programmed as a ZigBee router, i.e., it has to receive data from the end devices that are wirelessly connected to it (i.e., end devices that are not under the range of the coordinator), and forward this data to the coordinator.

The WISE-MUSE sensor node, which corresponds to the ZigBee end device, was designed and built from scratch, with a set of components to meet the proposed requirements. This is a node of small dimensions, which causes minimum impact at the Museum. Its low cost is one of the strengths of this sensor node (less than 70€). Another advantage is its low energy consumption.

To be more precise, the WISE-MUSE sensor node has four main blocks:

- *The power unit*, which is composed of two AA batteries and a step-up circuit that allows to

- guarantee the supply of a constant power (3.3V) to the microcontroller XBee and to the sensors;
- *The microcontroller* that is the "brain" of the node. It receives data from multiple individual sensors, processes it and, then, sends it through an XBee RF card;
- *Two specific sensors*: a light sensor that measures the brightness in the rooms of the Museum, and a sensor that measures both temperature and humidity;
- *The transceiver module* that transmits the collected data.

To guarantee an easy programming of the microcontroller, it was designed to be easily connected to a programmer, using the AVR-ISP500 protocol². Using this connection, the code can be easily updated whenever necessary. The chosen microcontroller is the Atmega 168 (Atmel, 2009), since it presents a set of characteristics that fits almost perfectly all our purposes; its low cost, low consumption and high performance are the main reasons for this choice.

The chosen sensor elements are the SHT15 humidity and the temperature sensor, from the Sensirion Company (Sensirion, 2009), and the S1087 photocell, from the Hamamatsu Company (Hamamatsu, 2009). The photocell captures the sunlight and returns a value of voltage to the microcontroller, which is then converted to the intensity of sunlight (LUX) unit values. The SHT15 sensor calculates the relative humidity and the temperature values. This is a totally calibrated CMOS industrial device, which allows a good stability at low cost. Its accuracy is much appropriated considering the requirements of the project (+/-2% for humidity, and +/-0.3°C for temperature).

In order to meet the power autonomy requirements of a sensor node, each node is powered by two AA batteries (1.5V each). These batteries have a capacity of 2450mAh and an output voltage of 1.5V. Their technology is the Nickel Metal hydride and they weight only 28g. Our goal is that the batteries last between 2 and 3 months, but this is still being tested.

Finally, the modules for RF transmission (XBee or XBbee PRO) are described. These modules were chosen because they require minimal power and because they provide a real and consistent delivery

of information between devices, operating at the 2.4GHz ISM frequency band. Although there are other options for RF transmission modules with lower power consumption, the popularity and characteristics of the XBee modules determined our choice.

Table 3 presents a comparison of sensor nodes that could be used in the environmental monitoring of museums. The characteristics of the nodes were considered as described in the manufacturers' datasheets. It is important to highlight that, in the current market, there are several RF modules separated from the sensing modules. Therefore, it was attempted to look beyond the prototype created in the project, by analysing other solutions that perform the collection and transmission of data in these indoor environments.

Analysing Table 3, there are several advantages and disadvantages of each solution proposed for monitoring environmental parameters. At the sensing module level, the sensors presented are quite similar. Most of the modules use the SHT15 or STH11 sensors, by Sensirion (2009), and their accuracy does not vary much, about +/-0.3°C for temperature and about +/-3% for relative humidity.

Almost all nodes collect light, temperature and humidity, with the exception of the Mica2 Sensor Board MTS101CA (Crossbow, 2009) that can not measure the humidity. The Mica Z (Crossbow, 2009) reads other kind of data, but this is not necessary in this application scenario. Besides, Mica Z has the disadvantage of a higher cost.

Regarding the microcontroller there are some considerable differences. Most microcontrollers are manufactured by Atmel (2009), with the exception to the Tmote Sky, which is manufactured by Sentilla (2009). Atmega devices (Atmel, 2009) have many features in common with our prototype. The WISE-MUSE prototype presents a flash memory with lower capacity; however, this factor should not be seen as a disadvantage since it conducts to a reduction on the amount of code programmed into the microcontroller. Consequently, the microcontroller has to process less amount of code what leads to a lower power consumption of the node. Therefore, it is not necessary a flash memory with more capacity. It was verified that the energy consumption of the WISE-MUSE prototype can be reduced when operating at a frequency of 1MHz. In these conditions, its consumption can be decreased to 0.3mA, which is a value smaller than for the other devices.

² AVR-ISP500 is USB low cost in-system programmer for AVR microcontrollers. It implements the STK500v2 protocol as defined by Atmel (2009). ISP stands for In-System Programmable.

Table 3 - Comparison between the WISE-MUSE mote and other commercially available motes.

SENSOR NODES					
Characteristics		WISE-MUSE	Mica 2 (MPR400CB) + Sensor Board (MTS101CA)	Mica Z (MPR2400CA) + Sensor Board (MTS400CB)	Tmote Sky
Produced by:		The authors at the UMa	Crossbow	Crossbow	Sentilla (former Moteiv)
Sensors	<i>Ambient parameters</i>	Light, relative humidity, temperature and battery level.	Light, temperature, and prototyping area	Light, relative humidity, temperature, 2-axis accelerometer, and barometric pressure	Humidity, temperature, and light
	<i>Temperature and humidity sensors</i>	SHT15	Termistor	SHT11	SHT11 or SHT15
	<i>Accuracy</i>	Temp: +/- 0.3C° Hum: +/- 2%	Temp: 0.2 C°	Temp: +/- 0.2°C Hum: +/- 3.5%	Temp: +/- 0.2°C or +/- 0.3C° Hum: +/- 3.5% or +/- 2%
	<i>Light Sensors</i>	S1087 by Hamamatsu	CdSe photocell	TLS2550, by TAOS	S1087, by Hamamatsu
Transceiver	<i>Module</i>	Xbee or Xbee PRO, both by Digi	Chipcon Wireless Transceiver	TI CC2420 802.15.4/ZigBee compliant radio	Chipcon Wireless Transceiver
	<i>Frequency</i>	2.4GHz	868/916 MHz, 433 MHz or 315MHz	2.4GHz	2.4GHz
	<i>Standard</i>	IEEE.802.15.4/ Zigbee	IEEE.802.15.4/ ZigBee	IEEE.802.15.4/ ZigBee	IEEE.802.15.4/ ZigBee
	<i>RF Power</i>	0dBm to 18dBm (PRO)	-20 to 5dBm	-24 to 0dBm	0dBm
	<i>Outdoor range*</i>	100mt to 1200m (PRO)	150mt	75 to 100mt	50 to 125mt
	<i>Current Draw (Tx)</i>	35mA @ 0dBm**	27mA @ 5dBm	17,4mA @ 0dBm	17,4mA @ 0dBm
Processor	<i>MCU</i>	Atmel, Atmega 168	Atmel, ATmega128L.	Atmel, ATmega128	Texas Instruments MSP430 microcontroller
	<i>Current Draw (in Active mode)</i>	0.3mA @ 1MHz 1.9mA @ 4MHz 6.8mA @ 8MHz	5mA @ 4MHz 17mA @ 8MHz	5mA @ 4MHz 17mA @ 8MHz	2.4mA @ 8MHz
	<i>Flash Memory</i>	16Kb	128kb	128kb	48kb
	<i>Programming access</i>	ISP	Base station	Base station	USB
	<i>Serial Communication</i>	UART	UART	UART	UART
	<i>Physical dimensions (mm) (Excluding battery pack)</i>	(58x28x12)	(58x32x10)	(58x28x10)	(65x32x22)
Sensor Node Price		70€	352€	***	82€

* Considering an outdoor environment without obstacles.

** The consumption of the XBee's module in RF transmission is certainly a little below 35mA, because this value is not totally spent with the RF transmission, but also includes some processing activities.

*** No information has been obtained so far on this feature, however as the sensing module of the Mica Z is superior than the Mica 2, the total cost of the module will be higher.

The Mica motes (Crossbow, 2009) must be programmed through a base station, which involves an additional cost. The Tmote Sky and the WISE-MUSE nodes offer an advantage over the others; they are more easily programmed. The Tmote is programmed using USB, while the WISE-MUSE prototype is programmed using the Olimex programmer that uses the AVR-ISP500 protocol.

In relation to the transceivers of each node, all of them use the IEEE.802.15.4 protocol, which is the most appropriate protocol for WSNs. The Mica 2 operates in the 868/916Mhz, 433MHz or 315MHz ranges, while the others use the 2.4GHz range.

Thus, it is believed that the XBee module used in the WISE-MUSE prototype is well ranked due to its higher power transmission. Using the XBee-PRO allows an even higher transmission range what is an advantage when comparing to the other nodes. Its disadvantage regards the energy consumption; however, the XBee is designed to enter in the sleep mode, waking up only in pre-defined time intervals to send data; this way, the problem of energy consumption is minimized.

Looking to the sensor nodes as a whole, they all have similar dimensions, but the WISE-MUSE mote has a very low cost when compared to the Mica motes.

In conclusion, it is important to note that the module created was designed and built for the specific indoor environmental monitoring at the Museum, presenting a number of advantages that may be attractive for this monitoring application, where its skills are within the requirements of the final client. Moreover, this new sensor node brings some advantages when compared to other commercially available solutions, such as low cost, small size, low power consumption, and higher transmission range.

3.6 Humidity Control Device

The humidity control device has been developed in the WISE-MUSE project to carry out the automatic control of dehumidifiers, in order to regulate relative

humidity levels inside the rooms where the WSN is deployed.

Figure 10 shows the developed control device. It is essentially composed of one XBee module, one relay, and one AC-DC converter, integrated in a box that allows the device to be plugged into an electrical outlet and, at the same time, to the dehumidifier, as depicted by Figure 11.

The dehumidifier is connected to an AC outlet, but the relay acts as an intermediary, closing or opening the circuit, depending on the commands sent by the coordinator. On the other hand, the AC outlet is also used to electrically supply the XBee radio. When the humidity values reach an unacceptable limit (these limits were specified by the Museum managers), the coordinator sends a control message by RF to the control device (more precisely to its XBee module, activating one of its pins). It receives the control message and analyses it. As a consequence, it activates the relay. If the humidity level is above the maximum limit then it turns on the dehumidifier. In opposite, if the humidity level is below the minimum limit, then it turns off the dehumidifier.

For the time being, the automatic control device was implemented only for dehumidifying devices, because the Museum does not have air conditioning devices. Nevertheless, the procedure for implementing the automatic control of air conditioning devices would be exactly the same.

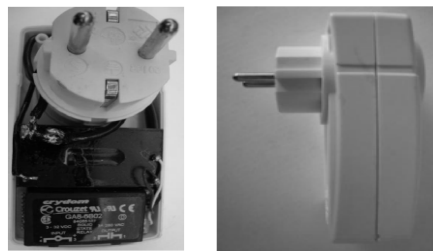

Figure 10. Humidity control device.

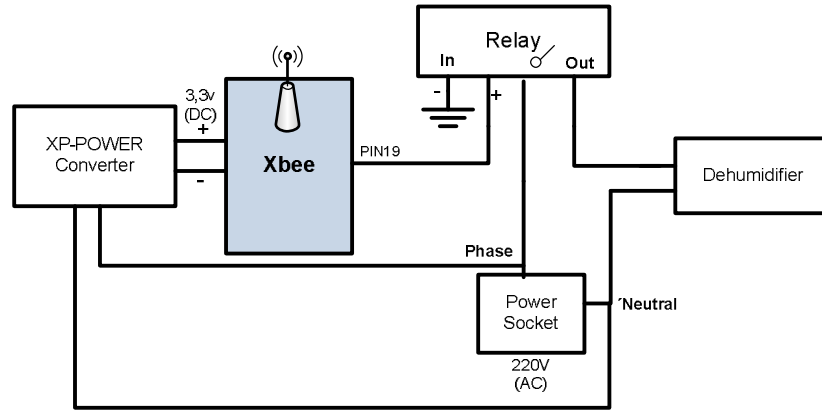

Figure 11- Components of the dehumidifier control device.

3.7 Experimental Results

In the deployed WSN, all data collected was centralized in a PC. To implement these tests and to capture data using a point-to-point connection, the WISE-MUSE prototype and an Xbee module as the coordinator were used. To visualize data the WISE-MUSE visualization tool was applied. Data was collected each 10 minutes and, based on that, our system generated graphs every hour. The monitoring period for the environmental parameters was 48 hours.

Figures 12 and 13 show the data captured by the WSN deployed in the Museum, namely the graphs for temperature and humidity. After analysing collected data, it was possible to draw some conclusions about the behaviour and the variations of temperature and humidity throughout the day.

Figure 12 presents the results of sensor 1 and sensor 2 placed in the storage room 1. It is possible to observe that the values obtained are similar in temperature between the two sensors, and remained between 20°C and 21°C during the day. The level of humidity captured by sensor 2 remained between 58% and 63%, which are normal values for the conditions and characteristics of the room. In opposite, the level of humidity captured by sensor 1 remained between 64% and 65%.

Figure 13 presents the data captured by sensors 3 and 4, which were placed in the storage room 2. Nodes 3 and 4 presented the highest values of humidity compared to node 1 and 2, near 75%Rh which has reached higher values until 1:30pm. After that, this level started to decrease. The highest humidity level for node 4 was 79%Rh and for node 3 was 75%Rh.

The data collected by the sensors were consistent, considering an error margin of $\pm 0.3^{\circ}\text{C}$ for temperature sensors and $\pm 2\%$ for the relative

humidity sensors. Indeed, the variation of data between the sensors is mainly due the error margin and their position in the storage room. In the near future, other tests should be carried out at the Museum for longer periods of time.

Figure 14 shows the battery status of the two AA batteries that are used on the WISE-MUSE prototype. Samples were collected during several days to get an estimated battery lifetime. Analysing the graph, it is possible to observe that the batteries' level follows typical discharge behaviour: in the first 10 days, the battery level dropped from 2.8V to 2.6V; however, from that point on, the battery level only dropped 0.1V during the next 30 days, which represents lower battery consumption. Therefore, after 40 days, the sensor node remains operational. Even though the decrease of the battery level does not follow a linear function, it is believed that the battery level will remain stable for some more days. Further tests will continue to be carried out, nevertheless, the WISE-MUSE prototype is supposed to have at least 1 month of autonomy, although its batteries can last for 2 months. These tests were performed on one node only, but in the future all the nodes should be tested.

It was verified that these environmental parameters are not as constant as they ideally should be. Therefore, it is very important that the WSN is connected to the air conditioning and dehumidifying systems in order to automatically control, above all, the temperature and the humidity of these rooms.

These results have an error skew, which is associated with each sensor; nevertheless, it is believed that these results show a good performance of the WISE-MUSE prototype. Some more adjustments will still be carried out in order to avoid some peak values that may occur.

3.8 Identified Problems

Several problems were identified during this experimental phase. These problems are not only related with the type of building where the WSN is being deployed but, also, with the hardware characteristics and resource limitations of the wireless sensor nodes.

- *Type of building* - Fortaleza São Tiago was built in the 17th century as a military fortress. Therefore, the width of the walls is very large (from 0.5 to 1m, with 1m being the predominant

width). The building has double doors and windows. It has an irregular shape and its rooms and terraces are distributed among three floors, as shown in Figure 2. All these factors influence and difficult the signal propagation and, consequently, the transmission range of sensor nodes.

- *Location of the building* - The museum is located by the sea, as can be seen in Figure 2, what obviously influences the humidity and temperature levels of the building.

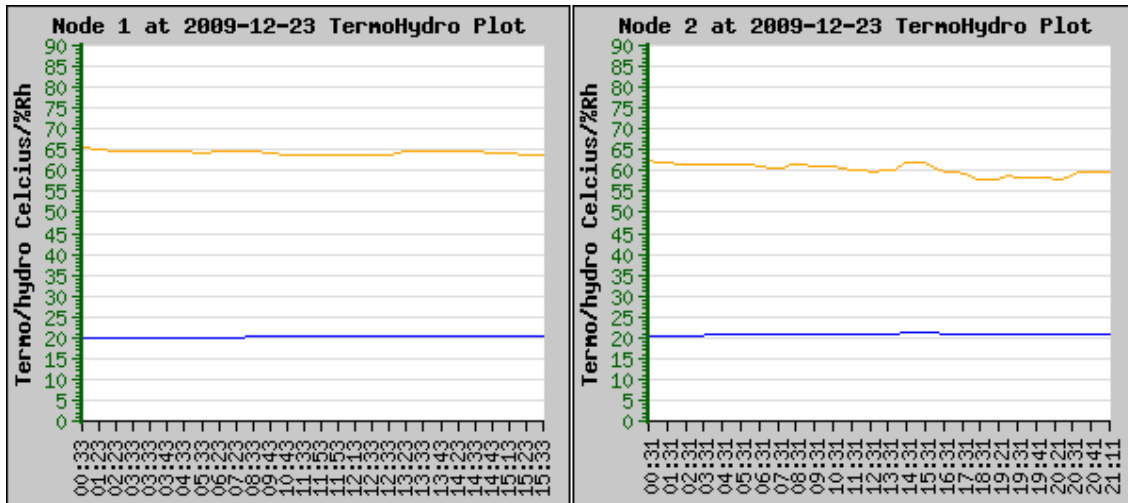

Figure 12. Terno/Hydro plots from node 1 and node 2.

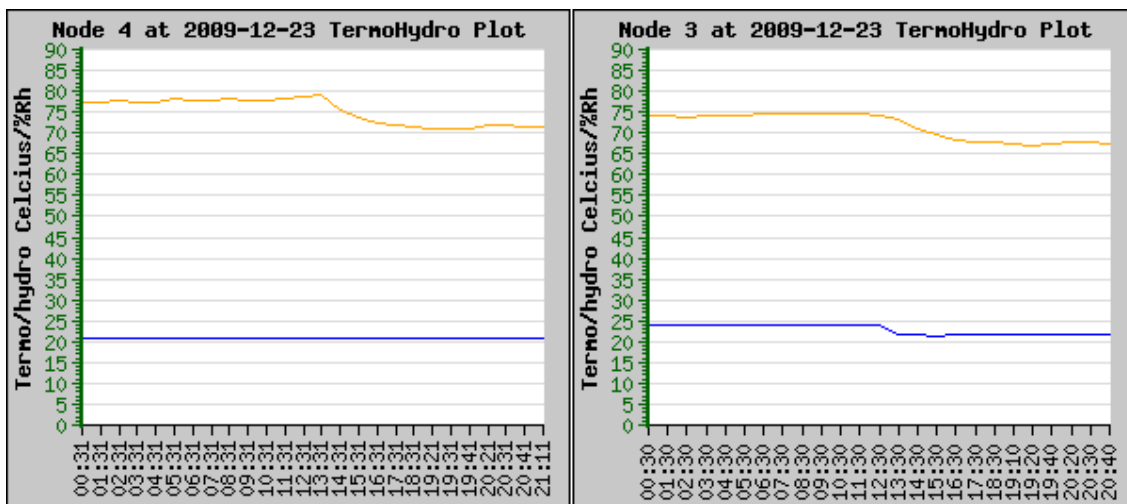

Figure 13. Terno/Hydro plots from node 4 and node 3.

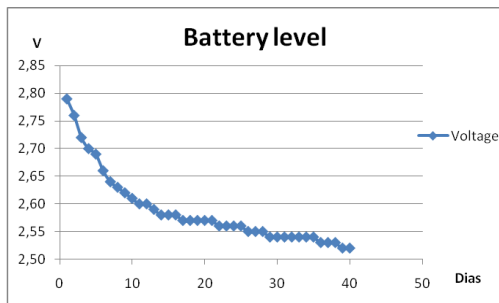

Figure 14. Average battery level.

- *Location of the sensor nodes* - Sensor nodes must not be placed near to the visitors' passageways, in order to avoid the risk of being stolen or damaged. Besides, nodes need to be located in rather discrete places. This will also help to minimize the visual impact caused by the nodes.
- *Transmission Range* - The transmission range of sensor nodes (XBee modules) is not as good as described in the manufacturer's datasheets, even in line-of-sight conditions. In order to increase the transmission range of sensor nodes, the XBee PRO modules had to be used (they have a higher transmission power than XBee standard modules). So, equipping the nodes with a better radio device increases the transmission range, but this obviously affects the energy consumption, which is a typical problem of WSNs. To minimize this problem, the number of measurements and transmissions per time period had to be decreased. Using a more efficient antenna can also help to decrease the energy consumption.
- *Type of antenna* – Nodes are equipped with omnidirectional antennas. Thus, the location of the nodes near the walls can cause signal reflections. Changing the type of antenna to a more efficient one (directional) will improve the signal propagation characteristics and, consequently increase the duration of the batteries.
- *Obstacles* – In the storage rooms, not only the shelves where the artworks are stored influence indoor signal propagation; its propagation is also influenced by wooden doors, glass windows and, above all, the walls. In the case of the exposition rooms, not only these factors influence the signal propagation, but the visitors themselves can also act as obstacles.

4. MONITORING SYSTEM FOR WSNs

Contrarily to traditional networks, WSNs are only useful if sensor nodes are aware of the environment surrounding them. This means that the great potential of WSNs relies on its ability to correlate collected data in time and in space (Broxton *et al.*, 2005; Hu & Servetto, 2005). This is one of the reasons why it was decided to develop a monitoring system for WSNs, which is composed by a 3D awareness tool and a visualization tool. These tools are being applied to the specific case of the WISE-MUSE project.

One of the most important properties of the awareness tool is the 3D representation of the network. This is very important so the user can have a more realistic view of the network, becoming more aware of the surrounding environment (different types of terrains or rooms, which obstacles might interfere with the collaboration established between nodes, etc.). This tool allows the visualization of different granularities: fine-grain (sensor nodes), middle-grain (clusters) and coarser (sessions) modelling level. Also, it allows an interactive navigation in the map of the network. Some screenshots of the awareness tool are presented in Figure 15. Its implementation is in a final stage.

Since this monitoring system is being applied to a museum's environmental monitoring, data visualization will be enhanced by integrating it in a 3D representation of the museum.

WSNs are extremely dynamic systems, both in the sense that their characteristics change over their lifetime and for the fact that sensor networks' technology (hardware and software) is subject to fast changes. To overcome this issue, any changes that might occur in the deployed WSN, obviously besides a new set of collected data, will be sent to the monitoring system, via new XML documents. Therefore, the collection of XML documents created during the network lifetime will represent a follow-up of both the data and the network evolution. Besides, this follow-up will be available for consulting whenever needed.

Thus, this tool will provide awareness, perceptibility in data monitoring, and visibility for problems detection and resolution. In essence, it will make the WSN monitoring more interesting and more intuitive, conducting to more successful decisions regarding the network maintenance.

4.1 WISE-MUSE Visualization Tool

The web-based visualization tool complements the 3D visualization of the WSN with the monitoring of collected data in several different formats (tables, graphs, colour gradients, etc.). It allows the visualization of data in a real-time basis or through data histories.

This visualization tool was mainly developed in PHP and allows monitoring the data captured by a WSN. This innovative tool simplifies the network management and proposes an application for non-specialized WSN users, thus simplifying the visualization of data, providing a working tool for environmental monitoring, while providing assistance in reports generation using the obtained information.

The main features of this tool are:

- Ability to display environmental parameters collected by the sensor nodes in a real scenario;
- Representation of the real topology map, showing the real position, state and data captured by each node;
- Generation of graphics based on stored data;
- Data exportation to Microsoft Excel and Word formats;
- Definition of the acceptable intervals for the monitored parameters.

Using the main menu located on the top of the home page of the visualization tool (Figs 16 and 17), one can access to plots (Fig. 18), environmental parameters, sensor nodes, and existing scenarios.

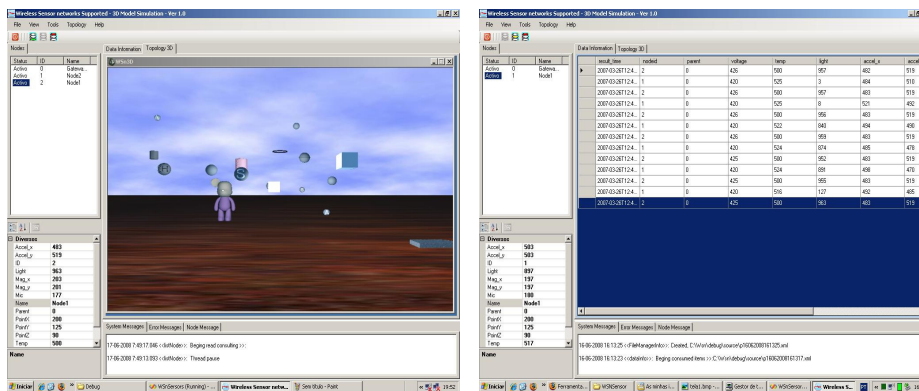

Figure 15. Some screenshots of the 3D awareness tool.

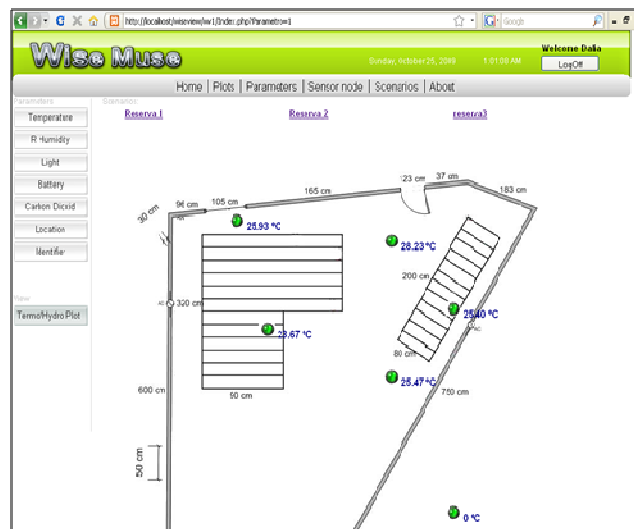

Figure 16. WISE-MUSE web-based visualization tool's home page.

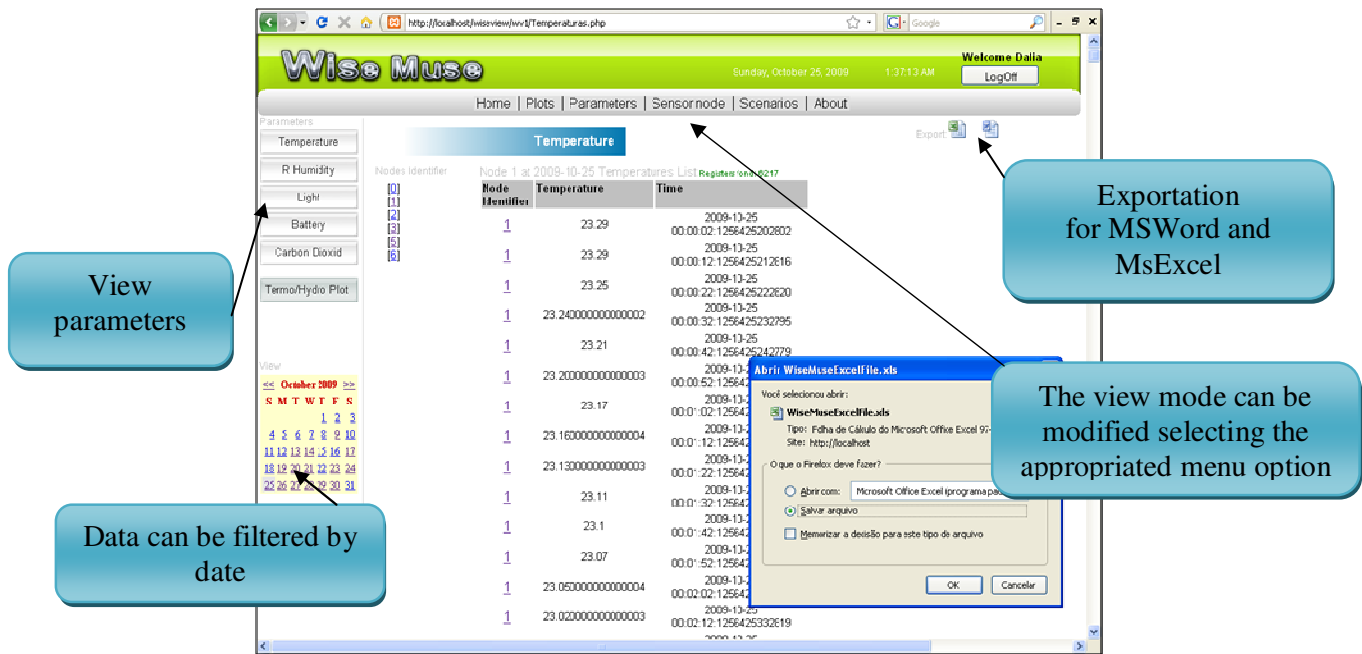

Figure 17. WISE-MUSE web-based visualization tool's functionalities.

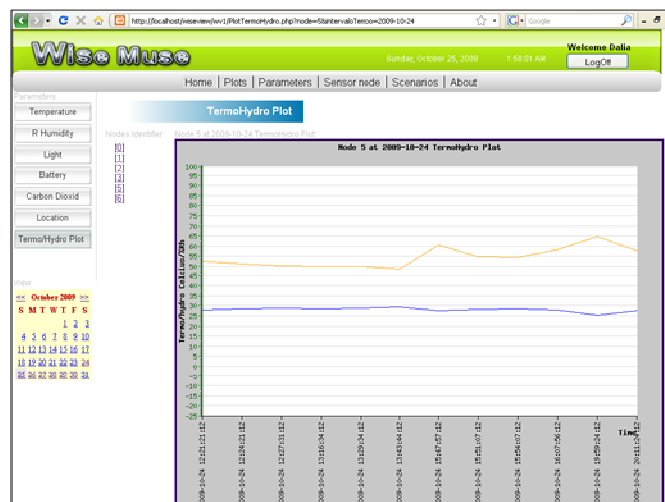

Figure 18. TermoHydroPlot screen.

4.1.1 Comparison of existing commercial solutions

Nowadays, there are some commercial applications that allow the visualization of WSNs. Nevertheless, most of them are more oriented to management-or deployment, or simply offer basic data visualization interfaces.

Comparing our proposed visualization tool with existing tools for monitoring and visualizing WSNs, it is possible to conclude that the WISE-MUSE visualization tool present the following advantages (see Table 4):

- Plot generation;
- WSN maps and real scenario visualization;

- Scenario customization through the addition of new maps;
- Data management and data historic generation;
- Exportation for MSWord and MExcel formats;
- Independence of the operating system and mobility.

Initially, the generation of alerts to the user was carried out through a visual feedback. However, this functionality has been improved by making this notification available through e-mail or SMS (this corresponds to the Sentinela security module, shown in Fig. 1).

Table 4 – Comparative table between WISE-MUSE visualization tool and commercial solutions.

Functionality	WISE-MUSE	SNA (Daintree, 2007)	TASK (Intel, 2004)	SpyGlass (Buchmann & Pfisterer, 2005)	Mote-View (Crossbow, 2005)	WebSensys (Wireless Value, 2009)
Graphic generation	✓	✓	✓	✓	✓	✓
Data exportation	✓				✓	
Maps and scenario visualization	✓	✓				
Sensors' relative positions visualization	✓	✓	✓	✓	✓	
Visualization of the sensor nodes position coordinates	✓				✓	
Alert generation					✓	✓
Data exportation	✓				✓	✓
Operating System independent	✓					✓
Manufacturer independent	✓	✓		✓		
Allow to add new scenarios	✓	✓			✓	

5. CONCLUSION

In this paper, some final results of the WISE MUSE project, which regards the deployment of a WSN for automatically and continuously monitoring and control the environment of a museum, were presented. The employment of WSNs to this context was compared with related commercial solutions, being outlined its advantages. Besides being a simpler solution, the use of WSNs for environmental monitoring of a museum is, indeed, a more reliable solution. It is also less expensive than manual data collection or than a wired central monitoring system.

The deployed WSN was described and, then, modelled and represented using the CWSN graph-based formal model, which brings several advantages to the users and network managers.

Several problems were identified during the WISE-MUSE project, but they can be essentially classified in two types: the problems related to the type of building where the WSN is being deployed, since it affects the signal propagation; and the problems related to the hardware characteristics and resource limitations of the sensor nodes, with the

battery being the most limited resource. Equipping the nodes with a more efficient antenna and using a higher number of nodes will lead to the need of a lower transmission power, increasing the duration of the batteries. Also, programming the nodes so that they perform less frequent measurements and transmissions will allow for high energy savings.

The graphs of collected data were also analysed, which allowed us to understand the behaviour and the type of variations of temperature, humidity and light, throughout the day.

One of the main contributions of our work is the development of a new sensor node created for environmental monitoring applications and the implementation of a Web-based visualization system that allows real-time environmental monitoring. Nevertheless, other advantages of the WISE-MUSE platform have been outlined when comparing to other commercially available solutions.

Furthermore, in order to increase the efficiency of this environmental monitoring system, by maintaining the humidity at more constant levels, a system that automatically controls the dehumidifying devices was implemented.

Moreover, a solution to automatically send an alert to the museum's manager if a significant

variation on at least one of the measured parameters occurs was implemented. These alerts are sent to a mobile phone (text message) or e-mail address.

6. FUTURE WORK

The deployment of the complete WSN that will cover the entire museum's exhibition rooms, storage rooms and library still has to be planned. The number of nodes and its location must be planned according to their transmission range and the existence of obstacles between them. In other words, the lessons learned in these experiments are going to be applied to create the whole WSN.

The WSN will be extended to monitor some pollutants, in particular the carbon dioxide (CO₂).

Besides, a system based in wireless video cameras will be installed to improve security by sending alerts in case of intrusion or robbery.

ACKNOWLEDGMENTS

We would like to express our gratitude to Filipe Santos who has collaborated in this project.

REFERENCES

Akyildiz, I., Su, W., Sankarasubramaniam, Y., Cayirci, E., "A Survey on Sensor Networks", *IEEE Computer Networks*, Vol. 38, No. 4, March 2002, pp. 393-422.

Atmel, June 2009, from <http://www.atmel.com/products/>

Brito, L., and Rodríguez, L., "A Collaborative Model for Representing Wireless Sensor Networks' Entities and Properties", *Proc. of the 3rd ACM International Workshop on Performance Monitoring, Measurement and Evaluation Heterogeneous Wireless and Wired Networks (PM2HW2N'08)*, Vancouver, British Columbia, Canada, October 31, pp. 104-111.

Brito, L., Rodríguez, L., Santos, F., and Fernandes, R., "Environmental Monitoring of Museums Based on Wireless Sensor Networks", *Proc. 4th International Conference on Wireless and Mobile Communications (ICWMC 2008)*, IEEE Computer Society Press, Athens, Greece, July 27 - August 1, 2008, pp. 364- 369.

Broxton, M., Lifton, J., and Paradiso, J., "Localizing a Sensor Network via Collaborative Processing of Global Stimuli", *Proc. 2nd European Workshop on Wireless Sensor Networks (EWSN'05)*, 31 Jan. - 2 Feb. 2005, pp. 321-332.

Buchmann C., and Pfisterer D., "SpyGlass: A wireless sensor network visualizer", *In Special issue: Best of Sensys 2004 work-in-progress*, ACM, Vol. 2, Issue 1, January 2005.

Crossbow, May 2009, from <http://www.xbow.com/>

Crossbow technology, Inc., "Mote-View user's Manual", 2005.

Daintree Networks, Inc., "Sensor Network Analyzer quick start guide", November 2007.

Del Curto, D., and Raimondi, F., "WISPHER: cooperating Wireless Sensors for the Preservation of artistic HERitage, Case study: Arena di Verona", *Adjunct Proc. of Embedded WiSeNis - Project FP6-004400*, Zurich, January 2006.

Digi, June 2009, from <http://www.digi.com/products/wireless/zigbee-mesh/>

Hamamatsu, June 2009, from http://jp.hamamatsu.com/en/product_info/index.html

Heidemman, J., and Bulusu, N., "Using Geospatial Information in Sensor Networks", Center for Embedded Network Sensing Papers. Paper 735, September 2001, from <http://repositories.cdlib.org/cens/wps/735>.

Hu, A., and Servetto, S., "Algorithmic Aspects of the Time Synchronization Problem in Large-Scale Sensor Networks", *Mobile Networks and Applications*, 2005 Springer Science + Business Media Inc., Vol. 10, No. 4, August 2005, pp. 491-503.

Intel Research, Berkeley, Task Visualizer documentation, 2004.

Lee, A., Angeles, C., Talampas, M., Sison, L., and Soriano, M., "MotesArt: Wireless Sensor Network for Monitoring Relative Humidity and Temperature in an Art Gallery", *IEEE International Conference on Networking, Sensing and Control (ICNSC 2008)*, April 2008, pp. 1263-1268.

Oldewurtel, F., and Mähönen, P., "Neural Wireless Sensor Networks", *International Conference on Systems and Networks Communications (ICSNC '06)*, October 2006, pp. 28.

Omega, April 2009, from <http://www.omega.com>

Onel, T., Onur, E., Ersoy, C., and Delic, H., "Advances in Sensing with Security Applications: Wireless sensor networks for security: issues and challenges", *Kluwer Academic Publishers Group*, January 2006, pp. 95-120.

Pai, S., Kurylosk, P., Yip, H., Yennamandra, S., Wicker, S., Boehner, K., and Gay, G., "Networks of Sensors in Public Spaces: Combining Technology with Art", *Proc. IEEE 21st Int. Conference on Advanced Information Networking and Applications (AINAW '07)*, Vol. 2, May 2007, pp. 396-402.

Rodríguez, L., Brito, L., and Gouveia, B., "The WISE-MUSE Project: Environmental Monitoring and Controlling of Museums based on Wireless Sensors Networks. *Electronic Journal of Structural Engineering (EJSE), Special Issue on Sensor Network for Building Monitoring: From Theory to Real Application*", October 2009, pp. 46 - 57.

Sensirion, "SHT1x / SHT7x, Humidity and Temperature Sensor Data sheet, V2.02", May 2009, from <http://www.sensirion.com/>

Sentilla (formerly, Moteiv Corporation), May 2009, from <http://www.sentilla.com/>

Spinwave Systems, April 2009, from <http://www.spinwavesystems.com/>

Wang, D., Zhang, Q., and Liu, J., "The Self-Protection Problem in Wireless Sensor Networks", *ACM Transactions on Sensor Networks (TOSN)*, Vol. 3, No. 4, Article no. 20, October 2007.

Wireless Value, WiSensys the wireless sensing system, June 2009, from www.wisensys.com.

ZigBee Alliance, 2004, from www.zigbee.org

2DI, April 2009, from <http://e2di.com/catalog.html>